

Version:  
July 31, 2017

# **DIRECT**

## **Electronics Tech.**

### **(TCB4F)**

# **SMD RF Baluns Transformer**

Web: [www.direct-token.com](http://www.direct-token.com)

Email: [rfq@direct-token.com](mailto:rfq@direct-token.com)

**Direct Electronics Industry Co., Ltd.**

**China:** 12F, Zhong Xing Industry Bld., Chuang Ye Road,  
Nan Shan District, Shen Zhen City,  
Guang Dong, China 518054  
Tel: +86 755 26055363; Fax: +86 755 26055365

**Taiwan:** No.137, Sec. 1, Zhongxing Rd., Wugu District,  
New Taipei City, Taiwan, R.O.C. 24872  
Tel: +886 2981 0109 Fax: +886 2988 7487

**► Product Introduction****Balun transformer resolves the challenge of interfacing differential RF circuits to single-ended ones.****Features :**

- Pair and triple wire coil for high stability and high balance.
- Available in tape & reel for automatic surface mounting..

**Applications :**

- Impedance Transformers.
- Broad-Band Transformers.
- Double Balance Mixers, Frequency Mixer.
- Common Mode Filter, Balun Transformers.

Direct Electronics has introduced SMD Common Mode RF Transformers (RF Balun Transformers) in 3.8 × 4.4 mm compact size, which are used to convert between unbalanced-balanced signals in the antenna inputs of tuner circuits for terrestrial digital broadcast compatible compact devices. Up to now baluns have been made by winding wire around a high-quality ferrite core, and are widely used in electronic devices such as TVs and desktop PCs.

Direct SMD RF Balun Transformers Frequency Mixer (TCB4F) is primarily designed for choking power lines and conform to the RoHS compliant and Lead-free. SMD (TCB4F) can be customized designs and tighter tolerances available on request.

Windings use paired or and triple wires for high uniformity. Base pins are end processed to allow direct mounting on PCB. The Balun transformers are ideal for use in double balanced mixers and as broad band transformers, transistors, impedance conversion, and frequency mixer for STB and Cable Modem. Application of SMD choke coils specific designs also available including different inductance values and Q specifications adjusted to frequency requirements.

Direct is equipped to design and produce standard and custom Balun components to meet many design and reliability demands. Custom parts are available on request. Direct will also produce devices outside these specifications to meet specific customer requirements, please contact our sales or link to Direct official website "[SMD Balun Transformers](http://www.direct-token.com)" for more information.



**Config. & Dim.**

**Configurations & Dimensions (Unit: mm) (TCB4F)**

Type	A	B (max)	C (max)	D	E (max)	F	G	H	I	J	K	L
TCB4F	3.8	4.4	3.2	2.0	5.5	0.45	3.0	2.7	4.4	1.3	3.0	1.0

SMD Common Mode RF Balun Transformer (TCB4F) Dimensions

● **Note: Design as Customer's Requested Specifications.**



► **TCB4F-617DB Spec A**

**Electrical Characteristics A (TCB4F - 617DB)**

Part Number	Winding Turns 1-6=2-4=2-6=3-4	$\mu$ iac
TCB4F - 617DB1673	2 1/2 T	300
TCB4F - 617DB1674	3 1/2 T	300
TCB4F - 617DB1675	4 1/2 T	300
TCB4F - 617DB1714	5 1/2 T	300

**Test Circuit A (TCB4F - 617DB)**

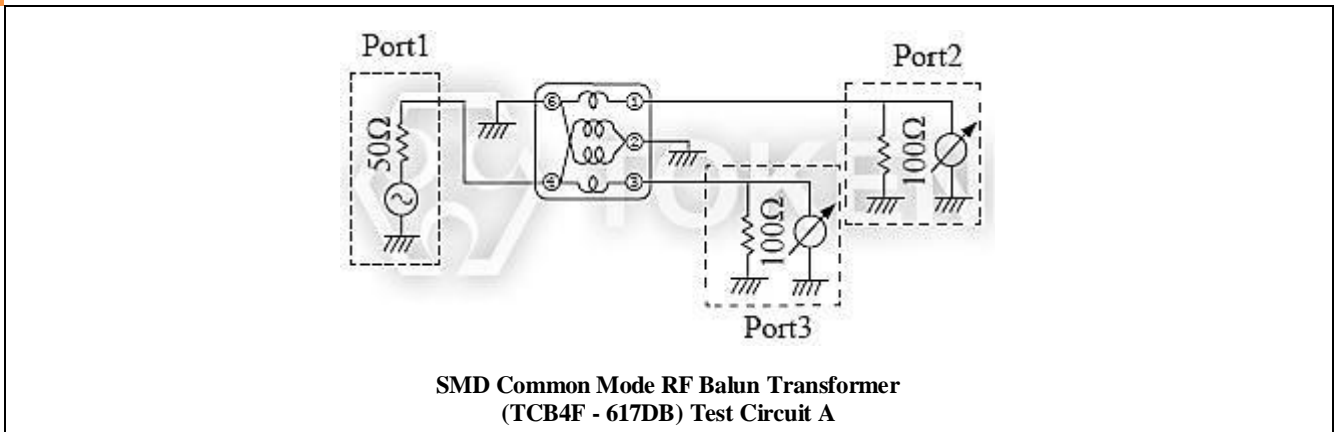

**Typical Characteristics A (TCB4F - 617DB)**

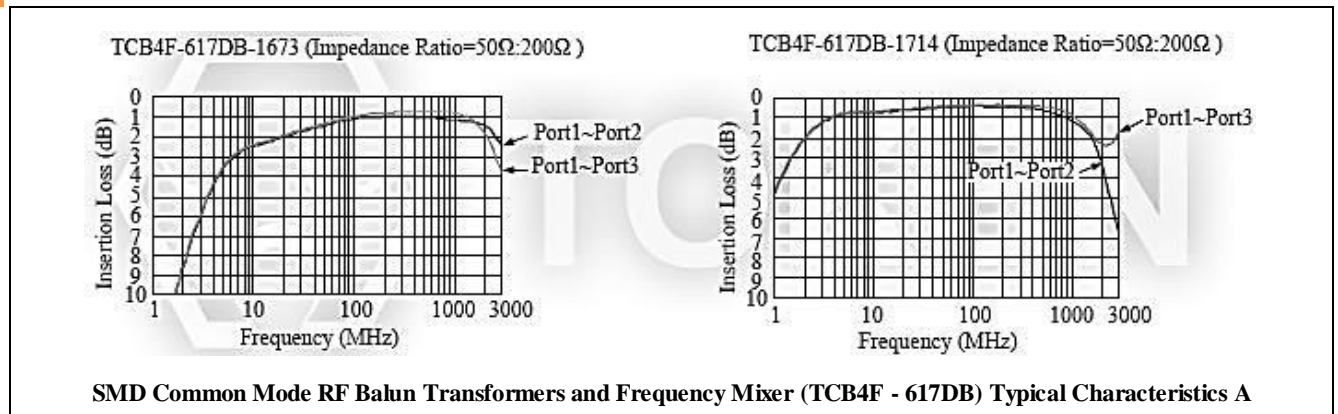

**TCB4F-617DB Spec B**

**Electrical Characteristics B (TCB4F - 617DB)**

Part Number	Winding Turns	$\mu$ iac
TCB4F - 617DB1653	2 1/2 T	300
TCB4F - 617DB1654	3 1/2 T	300
TCB4F - 617DB1655	4 1/2 T	300
TCB4F - 617DB1724	5 1/2 T	300

**Test Circuit B (TCB4F - 617DB)**

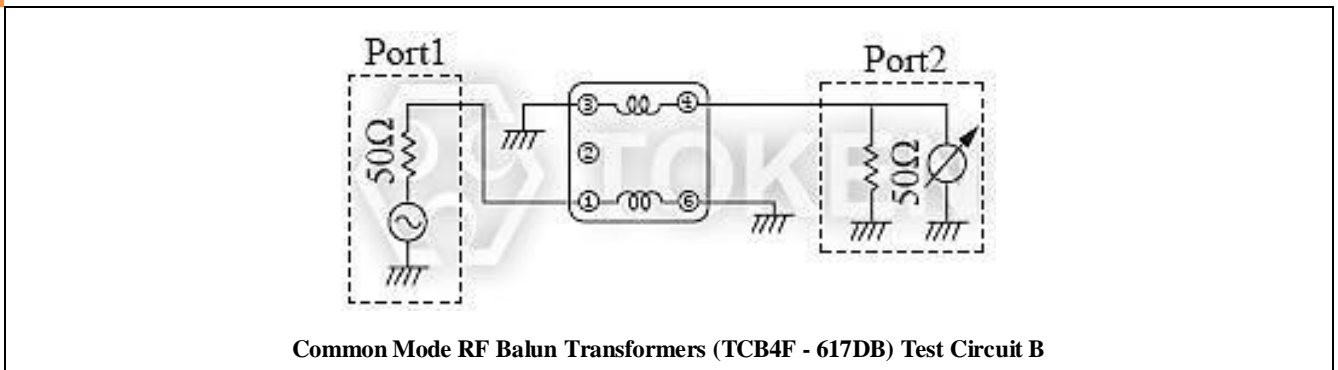

**Typical Characteristics B (TCB4F - 617DB)**

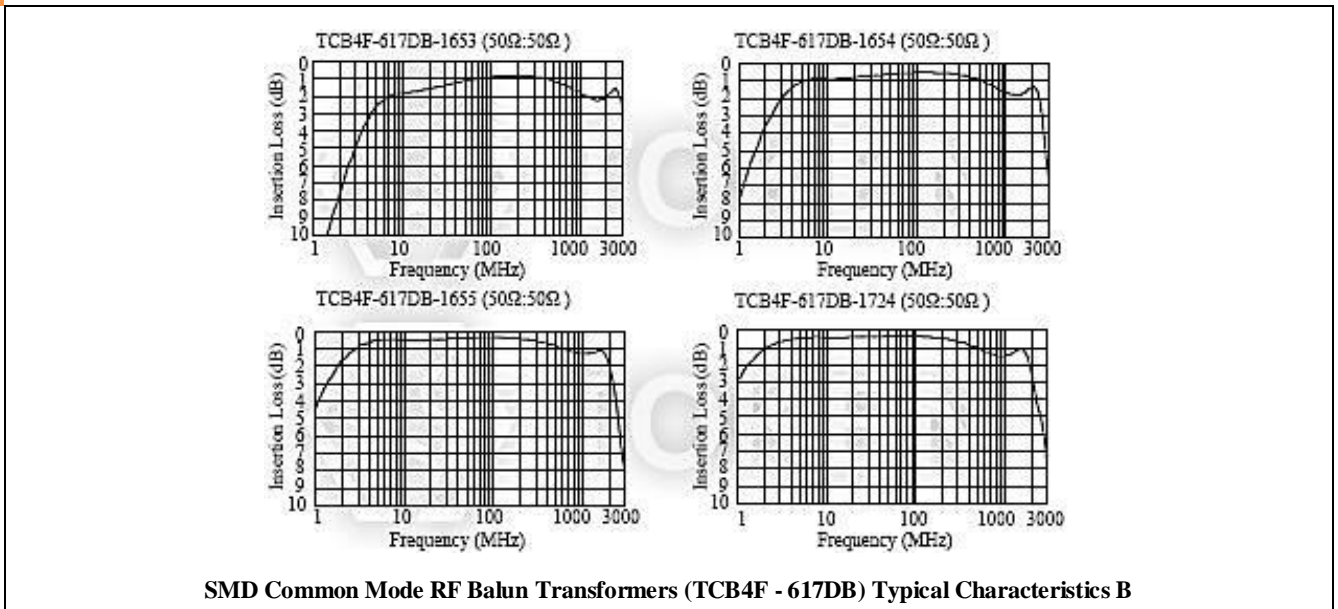

► **TCB4F-617DB Spec C**

**Electrical Characteristics C (TCB4F - 617DB)**

Part Number	Winding Turns	$\mu\text{iac}$
TCB4F - 617DB1643	2 1/2 T	1500
TCB4F - 617DB1644	3 1/2 T	1500
TCB4F - 617DB1645	4 1/2 T	1500
TCB4F - 617DB1646	5 1/2 T	1500

**Test Circuit C (TCB4F - 617DB)**

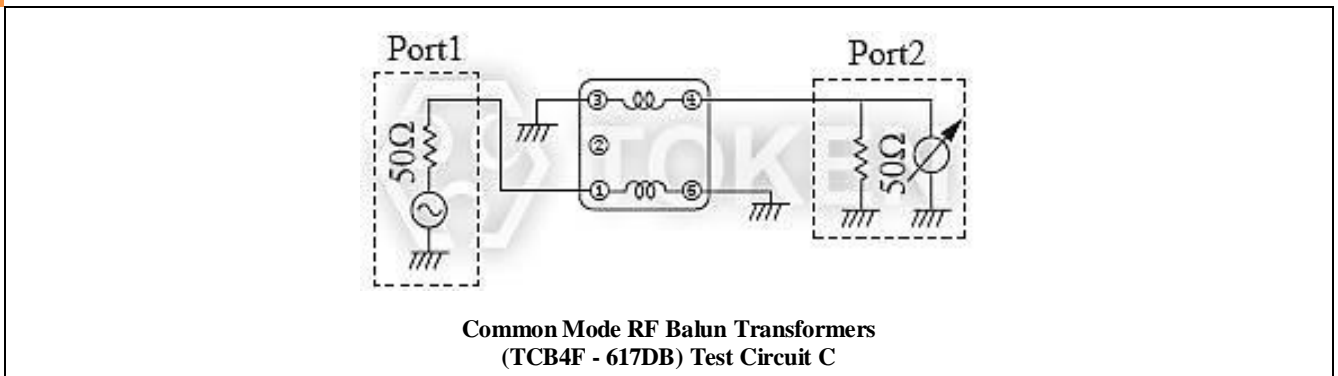

**Typical Characteristics C (TCB4F - 617DB)**

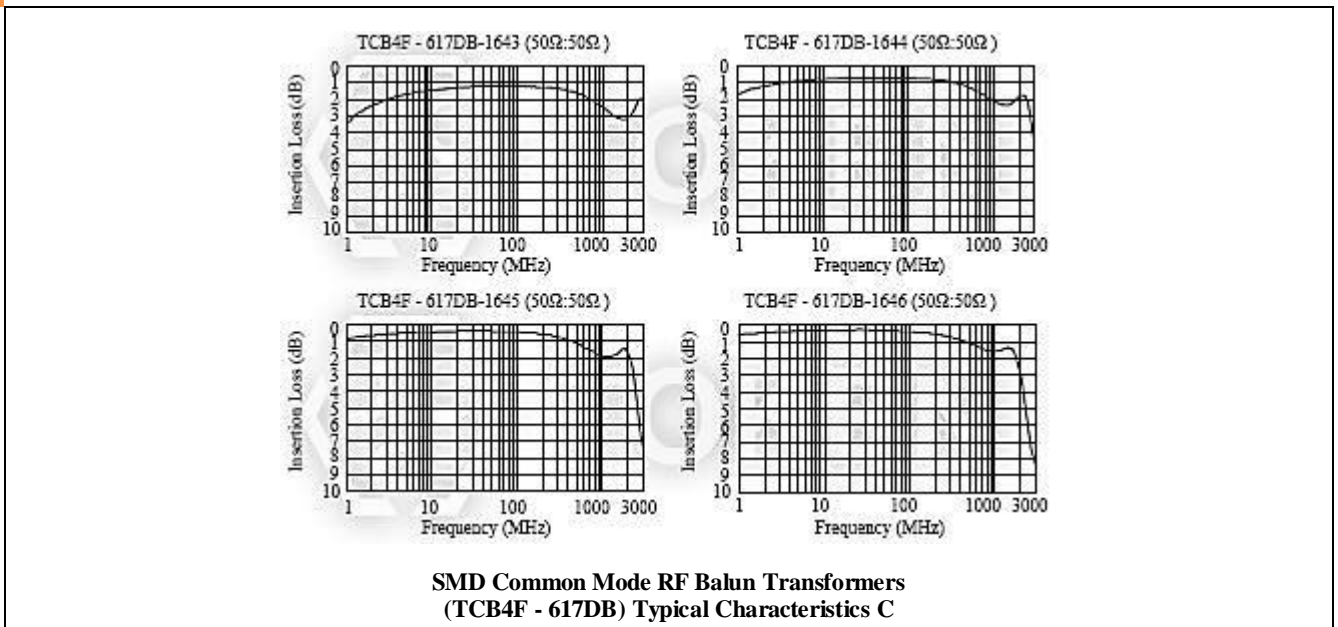

► **TCB4F-617PT Spec**

**Electrical Characteristics (TCB4F - 617PT)**

Part Number	Winding Turns 1-2=2-3=4-6	$\mu$ iac
TCB4F - 617PT1667	2T	300
TCB4F - 617PT1669	3T	300
TCB4F - 617PT1699	4T	300
TCB4F - 617PT1664	5T	300

**Test Circuit (TCB4F - 617PT)**

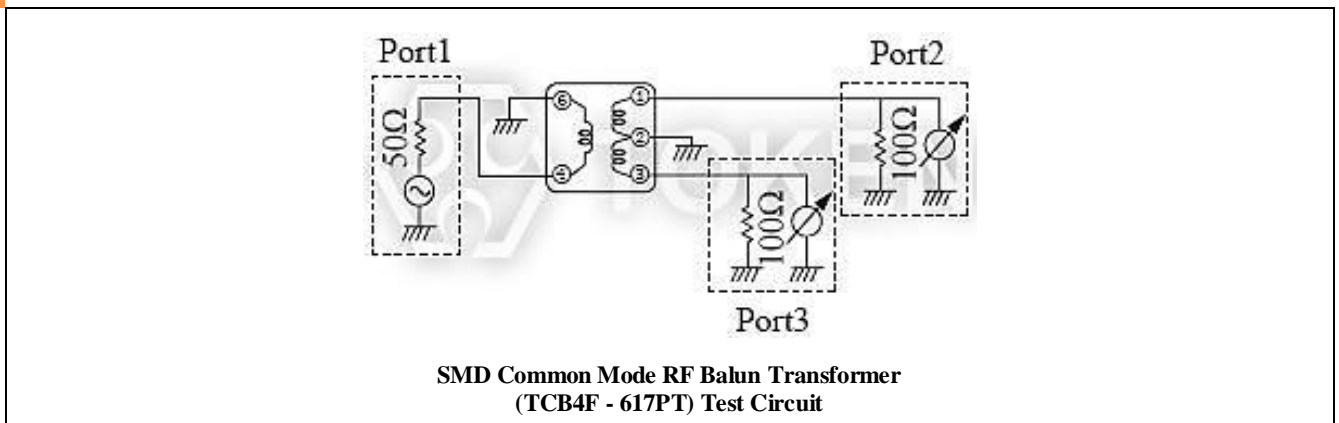

**Typical Characteristics (TCB4F - 617PT)**

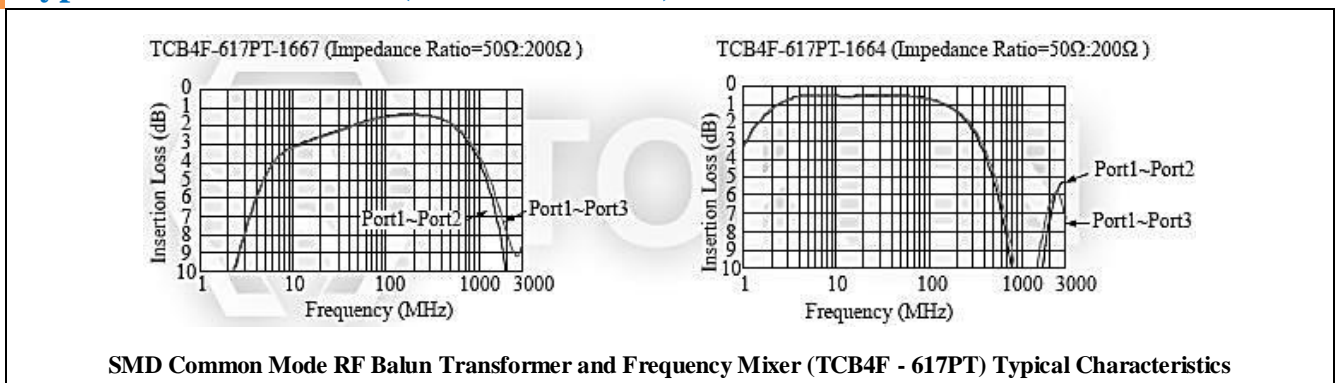

▶ **Order Codes**

**Order Codes (TCB4F)**

<b>TCB4F</b>	-	<b>617DB1673</b>	
Part Number		Type	
TCB4F		617DB1673	Frequency Mixer
		617PT1667	Frequency Mixer
		617DB1653	Balun Transformers
		617DB1643	Balun Transformers

▶ **General Information**

**Applications of Baluns**

In a **RF balun transformer**, one pair of terminals is balanced, that is, the currents are equal in magnitude and opposite in phase. The other pair of terminals is unbalanced; one side is connected to electrical ground and the other carries the signal. Balun transformers can be used between various parts of a wireless or cable communications system. Some common applications denotes as following:

- Television receiver (Balanced) - coaxial cable network or Coaxial antenna system (Unbalanced)
- FM broadcast receiver (Balanced) - Coaxial antenna system (Unbalanced)
- Dipole antenna (Balanced) - Coaxial transmission line (Unbalanced)
- Parallel-wire transmission line (Balanced) - Coaxial transmitter output, or Coaxial receiver input (Unbalanced)

Direct's baluns provide impedance transformation in addition to conversion between balanced and unbalanced signal modes. Most television and FM broadcast receivers are designed for 300-ohm balanced systems, while coaxial cables have characteristic impedances of 50 or 75 ohms. Impedance-transformer baluns with larger ratios are available and used to match high-impedance balanced antennas to low-impedance unbalanced wireless receivers, transmitters, or transceivers.

